

DORA GALA 6 RAFLI KİTAPLIK ATLANTİK ÇAM / NATUREL KURULUM ŞEMASI

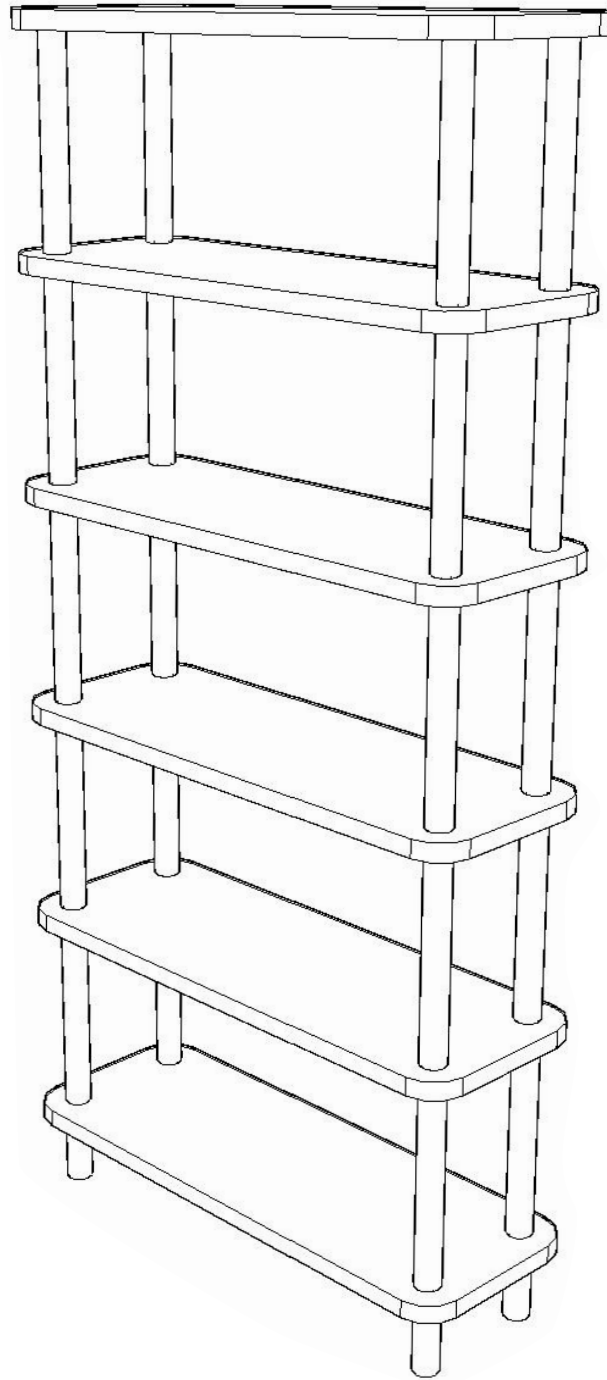

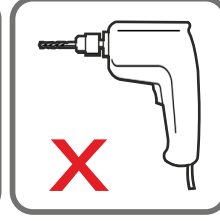

P.NO	ADET	BOY (mm)	EN (mm)	KALINLIK (mm)	PAKET
01	x1	800	280	25	1.PAKET
02	x5	800	280	25	1.PAKET

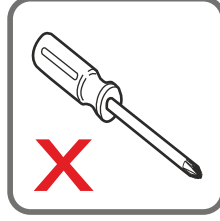
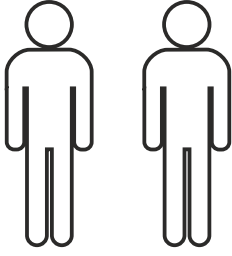
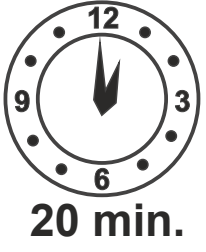
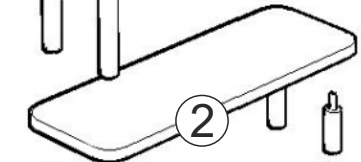
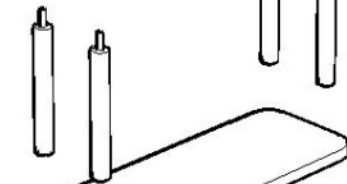
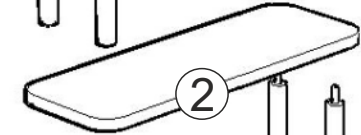
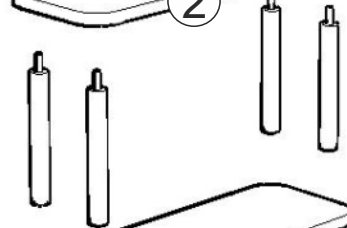
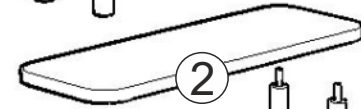
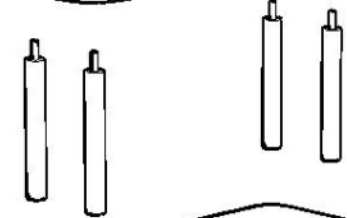
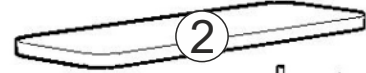
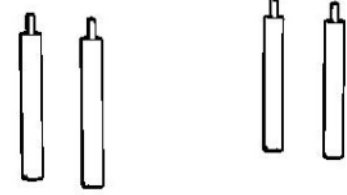
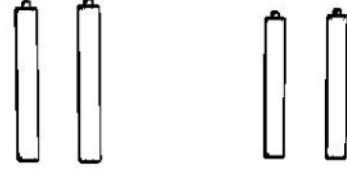



HM02273



HM02104

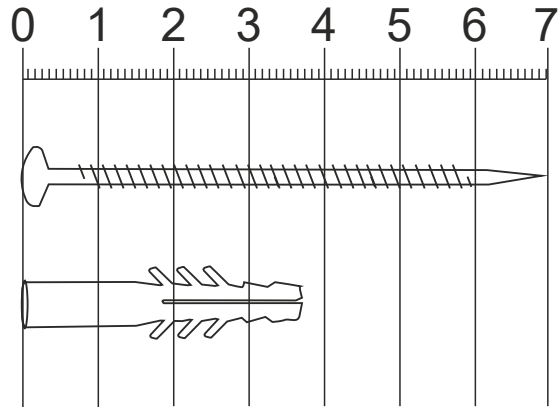

HM02095 X 4

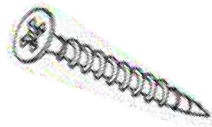

HM02273 X 1



HM02104 X 1



HM02211 X 1



HM02312 X 4



HM02313 X 16



HM02315 X 4

DİKKAT : 1 numaralı parçaya monte edilecek 4 adet ayağın klavuzlu kısımları, görselde gösterildiği gibi kısa olmalıdır. 2 numaralı parçaya monte edilecek diğer 16 adet ayağın klavuzlu kısımları ise görseldeki gibi uzun olmalıdır.

(The four legs to be mounted on part number 1 must have short guide ends as shown in the illustration.
The other sixteen legs to be mounted on part number 2 must have long guide ends as shown in the illustration.)

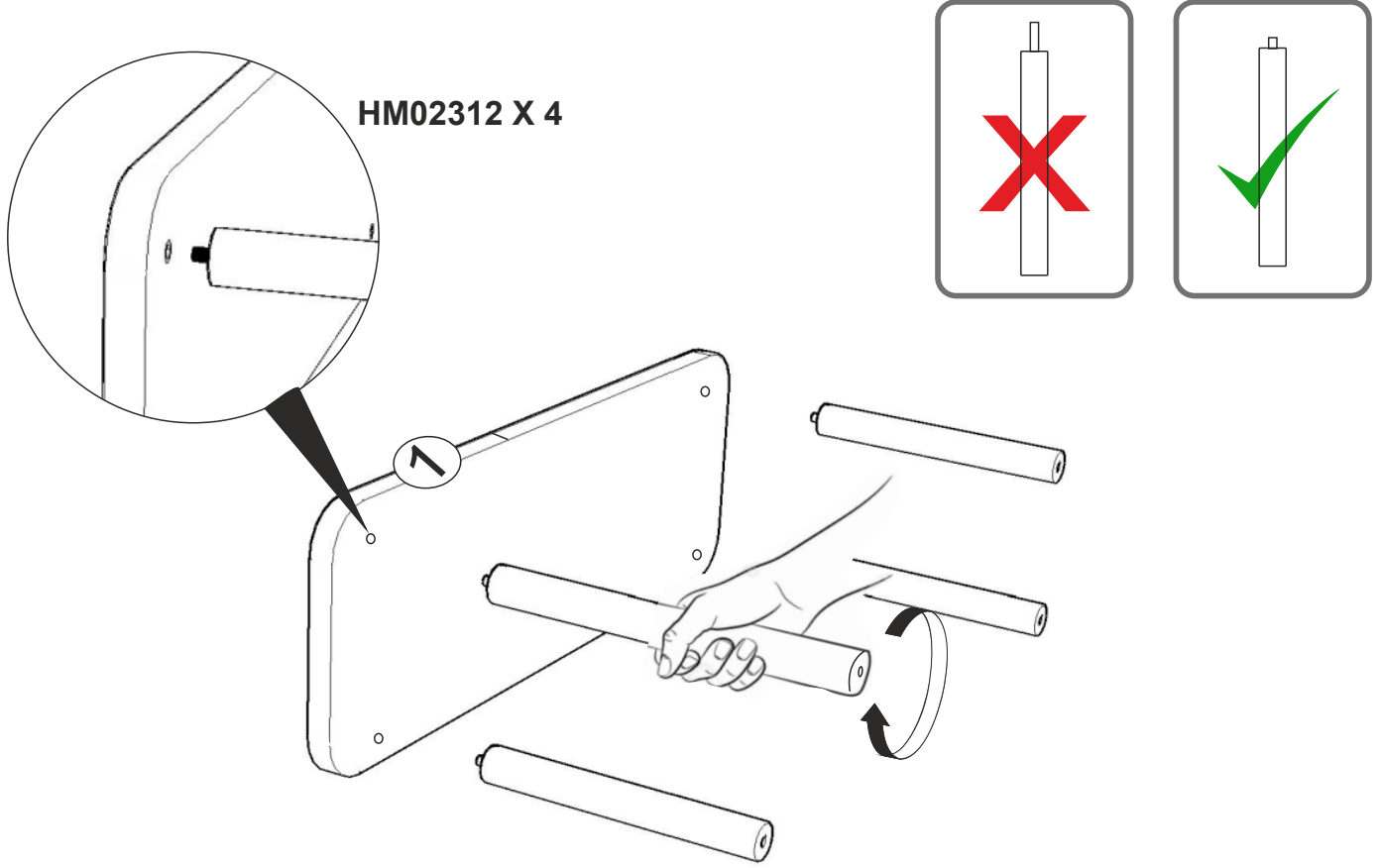

NOT : Rafların kenar bandı birleşim noktaları ürünün arka tarafında kalacak şekilde monte edilmelidir.

The edge band joint points of the shelves should be positioned at the back side of the product during assembly.

